



MADE IN ITALY

PEG PEREGO
via De Gasperi, 50
20862 Arcore (MB), Italy
Tel. +39-039-60881
Fax +39-039-615869

Assistenza - Customer Service
Tel. +39-039-6088213
Fax +39-039-3309992

Solo per l'Italia e solo
da telefono fisso:



pegperego.com



2019

In viaggio
con Peg Perego
Traveling with
Peg Perego



MADE IN ITALY

In viaggio con Peg Perego

Ovunque vogliate andare, il seggiolino auto Peg Perego è il compagno che vi assicura affidabilità e comodità.

Traveling with Peg Perego

Wherever you want to go, the Peg Perego car seat is a comfortable and reliable travel partner.

	NEONATI BABIES		BIMBI PICCOLI TODDLERS	DA BIMBI PICCOLI A BAMBINI FROM TODDLERS TO CHILDREN			BAMBINI CHILDREN			
	Kit Auto Culla Elite Kit Auto Culla Primonido	Primo Viaggio SL	Primo Viaggio i-Size	Viaggio FF105 (+ Base i-Size)	Viaggio 1 Duo-Fix K	Viaggio 1-2-3 Via	Viaggio 2-3 Surefix	Viaggio 2-3 Flex	Viaggio 2-3 Shuttle Plus	Viaggio 2-3 Shuttle
	Regulation ECE R44/04 Gruppo 0 Group 0	Regulation ECE R44/04 Gruppo 0+ Group 0+	Regulation ECE R129/00	Regulation ECE R129/00	Regulation ECE R44/04 Gruppo 1 Group 1	Regulation ECE R44/04 Gruppo 1-2-3 Group 1-2-3	Regulation ECE R44/04 Gruppo 2-3 Group 2-3	Regulation ECE R44/04 Gruppo 2-3 Group 2-3	Regulation ECE R44/04 Gruppo 2-3 Group 2-3	Regulation ECE R44/04 Gruppo 2-3 Group 2-3
			Base i-Size inclusa. Base i-Size included.	Base i-Size non inclusa. Base i-Size not included.		Da 1 a 12 anni. From 1 to 12 years.		Schienale pieghevole. Foldable backrest.	Schienale removibile. Removable backrest.	Senza schienale. Backless.
ALTEZZA HEIGHT	40 73 cm cm	45 80 cm cm	40 83 cm cm	71 105 cm cm	75 100 cm cm	75 150 cm cm	100 150 cm cm	100 150 cm cm	100 150 cm cm	100 150 cm cm
PESO WEIGHT fino a 10 up to kg fino a 13 up to kg fino a 13 up to kg	9 20 kg kg	9 18 kg kg	9 36 kg kg	15 36 kg kg	15 36 kg kg	15 36 kg kg	15 36 kg kg
ETÀ AGE	Nascita 9 Birth mesi months	Nascita 12 Birth mesi months	Nascita 15 Birth mesi months	1 4 anno year anni years	1 4 anno year anni years	1 12 anno year anni years	3 12 anni years anni years	3 12 anni years anni years	3 12 anni years anni years	3 12 anni years anni years





Kit Auto Culla Elite Kit Auto Culla Primonido

Gruppo 0
(da 0 a 10 kg)
da 0 a 9 mesi

Il Kit Auto comprende: cinturini a 3 punti dotati di spallacci e agganci per il trasporto auto, materassino auto, polistirolo di protezione.

Group 0
(from 0 to 10 kg)
from 0 to 9 months

The Car Kit comprises: 3-point harness with shoulder straps, attachments for use in the car, car mattress, protective polystyrene.



CULLA ELITE



CULLA PRIMONIDO

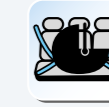

ORIENTAMENTO TRASVERSALE RISPETTO AL SENSO DI MARCIA. OMOLOGAZIONE SINGOLA. UN MODO DI FISSARLA IN AUTO: con le cinture di sicurezza a 3 punti dell'auto.

TRANSVERSE FACING. SINGLE TYPE-APPROVAL. ONE WAY TO FASTEN IT TO THE CAR: with 3-point safety belt.

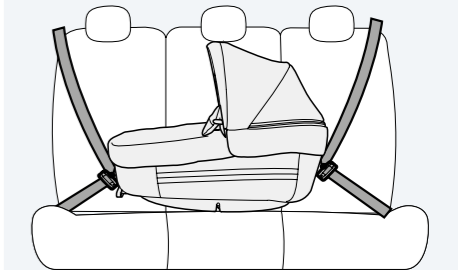
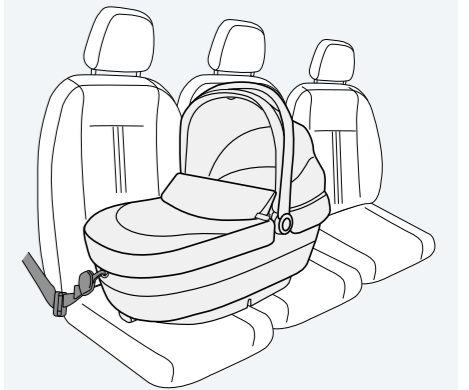

Nascita Birth	...	40 cm
...
9 mesi months	fino a up to 10 kg	73 cm

Primo Viaggio SL

Gruppo 0+

(da 0 a 13 kg)
da 0 a 1 anno

LEGERISSIMO E FACILE DA TRASPORTARE OVUNQUE.

Coordinato alle navicelle e ai passeggini.

Raggiunto il punteggio massimo di 5 stelle come migliore prodotto nella sua categoria nei crash test di sicurezza giugno 2013 condotti da ADAC, TCS, Stiftung Warentest, OAMTC.

Group 0+

(from 0 to 13 kg)
from 0 to 1 year

VERY LIGHT AND EASY TO TRANSPORT ANYWHERE.

Matching our bassinet units and strollers.

Achieved the maximum score of 5 stars as the best product in its category in the crash tests conducted in June 2013 by ADAC, TCS, Stiftung Warentest and OAMTC.



PROTEZIONE E ROBUSTEZZA

- 1: Guscio interno in EPS assorbe l'energia d'urto per una massima sicurezza.
- 2: Poggiatesta in EPS per una migliore protezione agli impatti e alla durata nel tempo.

PROTECTION AND DURABILITY

- 1: Energy-absorbing EPS-lined shell offers protection and is perforated to guarantee air circulation.
- 2: EPS-lined headrest is engineered for best impact protection and durability.



LUXE PURE

ADJUSTABLE SIDE IMPACT PROTECTION

Sistema di protezione agli impatti laterali, regolabile in 5 posizioni, per garantire la massima sicurezza in ogni momento della crescita del bambino.



ADJUSTABLE SIDE IMPACT PROTECTION

5-position adjustable side impact system, guaranteeing maximum safety as your child grows.

Cintura di sicurezza a 3 punti con morbide protezioni e cuscino anatomico per il neonato.

3-point safety belt with soft padding and an anatomic cushion for the newborn baby.



DALL'AUTO AL PASSEGGIO, FRONTE MAMMA O FRONTE MONDO.

FROM THE CAR TO THE STROLLER FACING MUM OR THE WORLD.



SENSO OPPOSTO AL SENSO DI MARCIA.

DOPPIA OMOLOGAZIONE. TRE MODI DI FISSARLO IN AUTO:

- 1: con le cinture di sicurezza a 3 punti dell'auto;
- 2: con Belted Base (acquistabile separatamente);
- 3: con Isofix Base 0+ 1 K (acquistabile separatamente).

REAR FACING.

DUAL TYPE-APPROVAL. THREE WAYS TO FASTEN IT TO THE CAR:

- 1: with 3-point safety belt;
- 2: with Belted Base (sold separately);
- 3: with Isofix Base 0+ 1 K (sold separately).

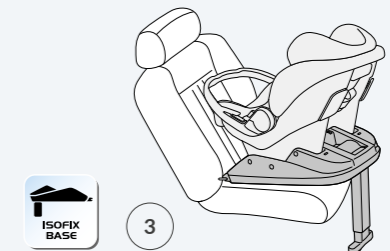
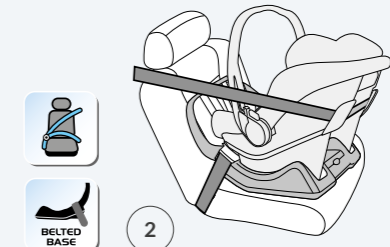
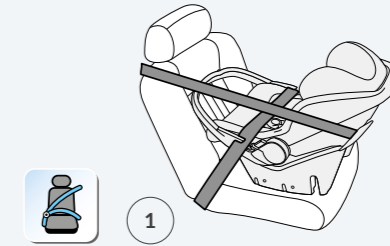

The Original Accessory

Isofix Base 0+ 1 K

Una base, 2 seggiolini auto, 4 anni di sicurezza insieme.

Tutta la sicurezza Isofix compatibile con Primo Viaggio SL e Viaggio1 Duo-Fix K.

One base, 2 car seats and 4 years of safety together. None of the Isofix safety is lost with the Primo Viaggio SL and Viaggio1 Duo-Fix K car seats.

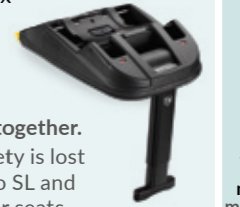

Belted Base

Per seggiolini auto, compatibile con Primo Viaggio SL.



Compatible with Primo Viaggio SL car seat.

Clima Cover Primo Viaggio

Rivestimento sfoderabile in TENCEL® Removable cover in TENCEL®



Igloo Cover Primo Viaggio

Sacchepiuma in Thermore® per seggiolini auto Primo Viaggio.

Cover in Thermore® to fit over Primo Viaggio car seats.



Rain Cover Primo Viaggio

Parapioggia per seggiolini auto Primo Viaggio.

Rain cover for Primo Viaggio car seats.



Primo Viaggio i-Size



Primo Viaggio i-Size è il seggiolino auto omologato secondo la nuova normativa ECE R129/00 i-Size completo di Base i-Size.

Primo Viaggio i-Size car seat is approved to the new ECE R129/00 standard and is equipped with i-Size Base.

Per bambini fino a 83 cm di lunghezza e 13 kg di peso (da 0 a 15 mesi).
Up to 83 cm height and 13 kg weight (from 0 to 15 months).

GRANDE SEGGIOLINO, GRANDE COMFORT, MASSIMA SICUREZZA E FACILITÀ D'USO.

Coordinato alle navicelle e ai passeggini.

LARGE SEAT, EXTREME COMFORT, MAXIMUM PROTECTION AND EASE OF USE.

Matching our bassinet units and strollers.



PAGODA HOOD

- Capottina estensibile con zip, protegge il bebè dagli agenti esterni.
- La capottina è predisposta per appendere il suo gioco preferito.
- Retina laterale per la ventilazione.
- UPF 50+

PAGODA HOOD

- Extendable hood with an easy-to-use zipper. It protects baby from all the elements.
- The child's favorite toy can be hung from the hood.
- Mesh side netting for ventilation.
- UPF 50+



Base i-Size (inclusa).

i-Size Base (included).

POLO



TRI-STAGE CUSHION

Segue la crescita del bebè per garantire maggiore comfort, supporto e sicurezza.

TRI-STAGE CUSHION

Follows baby's growth for more comfort, support and safety.



1: TESTA. Guscio interno in EPS assorbe l'energia in caso di urto.
HEAD. EPS-lined shell absorbs energy in a crash.

2: SCHIENA
BACK

3: SEDUTA
BOTTOM

ADJUSTABLE SIDE IMPACT PROTECTION

Sistema di protezione agli impatti laterali, regolabile in 6 posizioni, per garantire la massima sicurezza in ogni momento della crescita del bambino.

ADJUSTABLE SIDE IMPACT PROTECTION

6-position adjustable side impact system, guaranteeing maximum safety as your child grows.



DALL'AUTO AL PASSEGGIO, FRONTE MAMMA O FRONTE MONDO.

FROM THE CAR TO THE STROLLER FACING MUM OR THE WORLD.



SENSO OPPOSTO AL SENSO DI MARCIA.
DUE MODI DI FISSARLO IN AUTO:
1: con le cinture di sicurezza a 3 punti dell'auto;
2: con Base i-Size.

REAR FACING.
TWO WAYS TO FASTEN IT TO THE CAR:
1: with 3-point safety belt;
2: with i-Size Base.

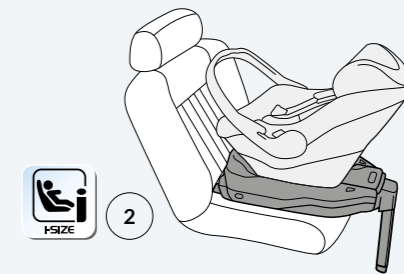
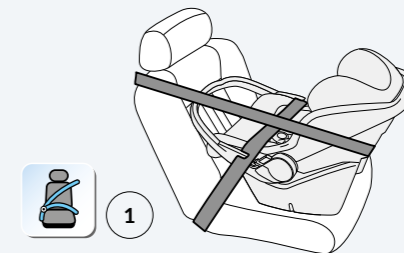

The Original Accessory

Base i-Size

Una base, 2 seggiolini auto, 4 anni di sicurezza insieme. Tutta la sicurezza i-Size compatibile con Primo Viaggio i-Plus e Viaggio FF105.

One base, 2 car seats and 4 years of safety together. None of the i-Size safety is lost with the Primo Viaggio i-Plus and Viaggio FF105.



Clima Cover Primo Viaggio

Rivestimento sfoderabile in Tencel®
Removable cover in Tencel®

Igloo Cover Primo Viaggio

Saccopiuma in Thermore® per seggiolini auto Primo Viaggio.
Cover in Thermore® to fit over Primo Viaggio car seats.



Rain Cover Primo Viaggio

Parapioggia per seggiolini auto Primo Viaggio.
Rain cover for Primo Viaggio car seats.



Nascita Birth



15 mesi months



fino a up to

13 kg

83 cm

40 cm

83 cm

Primo Viaggio i-Size



Cintura di sicurezza a 3 punti con morbide protezioni e Tri-Stage cushion.

3-point safety belt with soft padding and Tri-Stage cushion.



PROTEZIONE E ROBUSTEZZA

- 1: Guscio interno in EPS assorbe l'energia d'urto per una massima sicurezza.
- 2: Poggiatesta in EPP per una migliore protezione agli impatti e alla durata nel tempo.

PROTECTION AND DURABILITY

- 1: Energy-absorbing EPS-lined shell offers protection and is perforated to guarantee air circulation.
- 2: EPP-lined headrest is engineered for best impact protection and durability.

Base i-Size

CONNETTORI ISOFIX
Massima sicurezza e semplicità d'uso.

ISOFIX CONNECTORS
Maximum protection and ease of use.



BLIND LOCK SYSTEM

Evita che il seggiolino venga inavvertitamente sganciato da un altro passeggero.

BLIND LOCK SYSTEM

Prevents the car seat from being accidentally released by another passenger.

LOAD LEG
Regolabile in 12 posizioni.

LOAD LEG
Adjustable into 12 different positions.



Gli indicatori rossi/verdi indicano quando il seggiolino è correttamente agganciato alla base.

Red/Green indicators state when the seat is correctly attached to the base.



Gli indicatori rossi/verdi, situati su entrambi i lati e sulla parte superiore della base, indicano quando i connettori Isofix sono correttamente agganciati al sedile del veicolo.

Red/Green indicators, located on either side and on the top of the base, state when Isofix connectors are correctly fastened to the vehicle seat.

★ Viaggio System i-Size ★



From baby... to toddler



Primo Viaggio i-Size
(Base inclusa / Base included).

UNA SOLA BASE
dalla nascita
fino a 20 kg.

ONLY
ONE BASE
from birth
up to 20 kg.



Viaggio FF105.

40 - 83 cm (up to 13 kg)

71 - 105 cm (up to 20 kg)

Quando il bimbo cresce continua a utilizzare la Base i-Size con il seggiolino auto **VIAGGIO FF105** (pag. 14) omologato in senso di marcia fino a 105 cm di altezza del bambino e 20 kg.

When the child grows up, you can continue using the i-Size Base with **VIAGGIO FF105** (page 14) forward-facing car seat, which is approved for children up to 105 cm and 20 kg.

Bimbi piccoli
Toddlers



Viaggio FF105



Viaggio FF105 è il seggiolino auto omologato secondo la nuova normativa ECE R129/00 i-Size. Da utilizzare esclusivamente con Base i-Size (non inclusa).

Viaggio FF105 car seat is approved to the new ECE R129/00 standard. Only with i-Size Base (not included).

Per bambini da 71 fino a 105 cm di lunghezza e 20 kg di peso (da 1 a 4 anni).

From 71 up to 105 cm height and 20 kg weight (from 1 to 4 years).

IL SEGGIOLINO SUCCESSIVO AL TUO PRIMO VIAGGIO i-SIZE.

THE NEXT CAR SEAT UP FROM YOUR PRIMO VIAGGIO i-SIZE.



Prolunga l'uso della Base i-Size con il seggiolino Viaggio FF105.
Use the i-Size Base longer with Viaggio FF105 car seat.



Poggiatesta regolabile in 6 posizioni.

Headrest adjusts to 6 positions.

Utilizzabile SOLO con Base i-Size (non inclusa).

Use ONLY with i-Size Base (not included).

Cinture di sicurezza a 5 punti con morbidi spallacci.

5-point harness with soft shoulder pads.

CHEST CLIP
Mantiene la posizione corretta dei cinturini.

CHEST CLIP
Keeps the harness in the correct position.



INFINITE RECLINE
Schienale reclinabile in più posizioni.

INFINITE RECLINE
Reclining backrest to different positions.



IN SENSO DI MARCIA.
UN MODO DI FISSARLO IN AUTO:
1: con Base i-Size (non inclusa).

FORWARD FACING.
ONE WAY TO FASTEN IT TO THE CAR:
1: with i-Size Base (not included).



The Original Accessory

Base i-Size

Una base, 2 seggiolini auto, 4 anni di sicurezza insieme. Tutta la sicurezza i-Size compatibile con Primo Viaggio i-Plus e Viaggio FF105.

One base, 2 car seats and 4 years of safety together. None of the i-Size safety is lost with the Primo Viaggio i-Plus and Viaggio FF105.



Clima Cover Viaggio FF105

Rivestimento sfoderabile in TENCEL®
Removable cover in TENCEL®

Travel Bag Car Seat

Borsa di trasporto per seggiolini auto Peg Perego.

Travel bag for Peg Perego car seats.



1 anno year

9 kg

71 cm

4 anni years

20 kg

105 cm

Viaggio FF105



PROTEZIONE E ROBUSTEZZA
Poggiatesta in EPS per una migliore protezione agli impatti e alla durata nel tempo.

PROTECTION AND DURABILITY
EPS-lined headrest is for best impact protection and durability.



KINETIC PODS
Massima protezione contro gli urti laterali.

KINETIC PODS
Help to move forces away from your child in case of a side collision.



HARNESS RETAINER
Accomodi il bambino più facilmente.

HARNESS RETAINER
Holds harness out of the way when installing baby.



Cuscino riduttore anatomico.
Anatomic baby cushion.



ADJUSTABLE SIDE IMPACT PROTECTION
Sistema di protezione agli impatti laterali, regolabile in 6 posizioni, per garantire la massima sicurezza in ogni momento della crescita del bambino.

ADJUSTABLE SIDE IMPACT PROTECTION
6-position adjustable side impact system, guaranteeing maximum safety as your child grows.



Portabibite (incluso).
Cup holder (included).



EBONY



POLO



MARTE

1 anno year	9 kg	71 cm
4 anni years	20 kg	105 cm

Viaggio 1 Duo-Fix K

Gruppo 1
(da 9 a 18 kg)
da 1 a 4 anni

**MASSIMA SICUREZZA
IN AUTO DA 1 A 4 ANNI.**

Raggiunto il punteggio di 4 stelle nella sua categoria, nei crash test di sicurezza giugno 2013 condotti da ADAC, TCS, Stiftung Warentest, OAMTC.

Group 1
(from 9 to 18 kg)
from 1 to 4 years

**MAXIMUM SAFETY
FROM 1 TO 4 YEARS.**

Achieved a score of 4 stars in its category in the crash tests conducted in June 2013 by ADAC, TCS, Stiftung Warentest and OAMTC.



Cinture di sicurezza complete di spallacci regolabili, riposizionabili sulla seduta grazie al sistema di bloccaggio per facilitare il posizionamento del bimbo. Seduta ampia e imbottita con cuscino riduttore.

Safety harness complete with adjustable shoulder pads, which can be repositioned on the seat thanks to the fastening system to allow easy positioning of your child. Broad, padded seat with booster cushion.

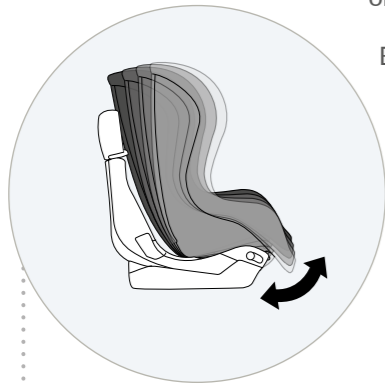

La seduta può assumere 4 posizioni di inclinazione distinte, garantendo al bambino lunghi viaggi comodi in completo relax, anche quando dorme.

The seat can be reclined into 4 different positions, so the child can fully relax on long journeys, even when sleeping.



ROUGE

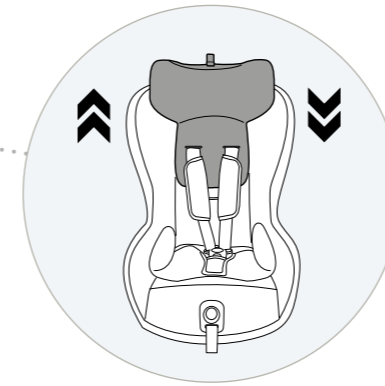

ADJUSTABLE SIDE IMPACT PROTECTION
Sistema di protezione agli impatti laterali, regolabile in 7 posizioni, per garantire la massima sicurezza in ogni momento della crescita del bambino.

ADJUSTABLE SIDE IMPACT PROTECTION
7-position adjustable side impact system, guaranteeing maximum safety as your child grows.



BLACK



SAND



**IN SENSO DI MARCIA.
DOPPIA OMOLOGAZIONE.
DUE MODI DI FISSARLO IN AUTO:**
1: con le cinture di sicurezza a 3 punti dell'auto;
2: con Isofix Base 0+ 1 K (acquistabile separatamente).

**FORWARD FACING.
DUAL TYPE-APPROVAL.
TWO WAYS TO FASTEN IT TO THE CAR:**
1: with 3-point safety belt;
2: with Isofix Base 0+ 1 K (sold separately).



1

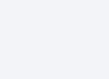
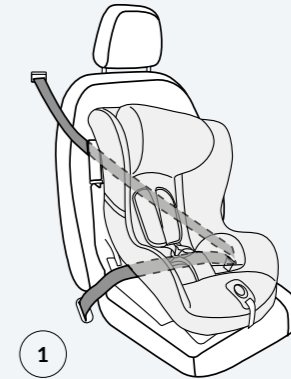

2



The Original Accessory



1 anno

9 kg

4 anni



18 kg

100 cm

75 cm

Isofix Base 0+ 1 K
Tutta la sicurezza Isofix compatibile con Primo Viaggio SL e Viaggio1 Duo-Fix K.

None of the Isofix safety is lost with the Primo Viaggio SL and Viaggio1 Duo-Fix K car seats.

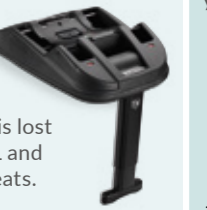

Clima Cover Viaggio 1 Duo-Fix K
Rivestimento sfoderabile in Tencel®

Removable cover in Tencel®

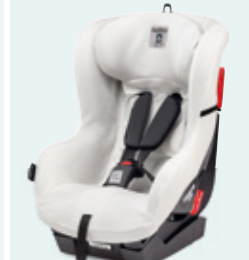

Car Seat Cup Holder
Portabile. Cup holder.



Travel Bag Car Seat
Borsa di trasporto per seggiolini auto Peg Perego.

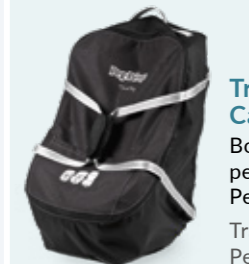

Travel bag for Peg Perego car seats.

Da bimbi piccoli a bambini
From toddlers to children

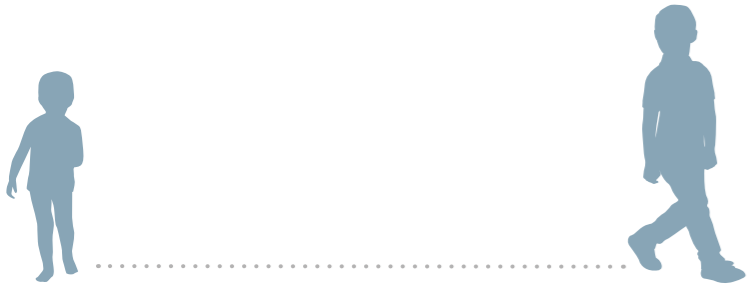

Viaggio 1-2-3 Via

Gruppo 1-2-3

(da 9 a 36 kg)
da 1 a 12 anni

IL SEGGIOLINO ISOFIX E TOP TETHER.

Group 1-2-3

(from 9 to 36 kg)
from 1 to 12 years

THE ISOFIX CAR SEAT AND TOP TETHER.



4D TOTAL ADJUST



- 1: Il poggiatesta si regola in altezza in 6 posizioni rispetto allo schienale.
- 1: The headrest can be adjusted to 6 height positions in relation to the backrest.

- 2: La parte superiore (schienale e poggiatesta) si regola in altezza in 5 posizioni.
- 2: The upper part (backrest and headrest) can be adjusted to 5 positions.

- 3: Le protezioni laterali si aprono permettendo di variare la larghezza del seggiolino di ben 6 centimetri.
- 3: The side protections open out so the width of the seat can be extended by up to 6 centimeters.

BLIND LOCK SYSTEM
Evita che il seggiolino venga inavvertitamente sganciato da un altro passeggero.

BLIND LOCK SYSTEM
Prevents the car seat from being accidentally released by another passenger.

CRYSTAL BLACK



IN SENSO DI MARCIA.
OMOLOGAZIONE:
Gruppo 1 (9-18 kg), categoria UNIVERSALE Classe B1, installato con Isofix e Top Tether e utilizzato con le cinture di sicurezza integrali a 5 punti del seggiolino.

FRONT FACING.
APPROVAL:
Group 1 (9-18 kg), UNIVERSAL category Class B1, installed with Isofix and Top Tether and used with the car seat 5-point integral safety harness.

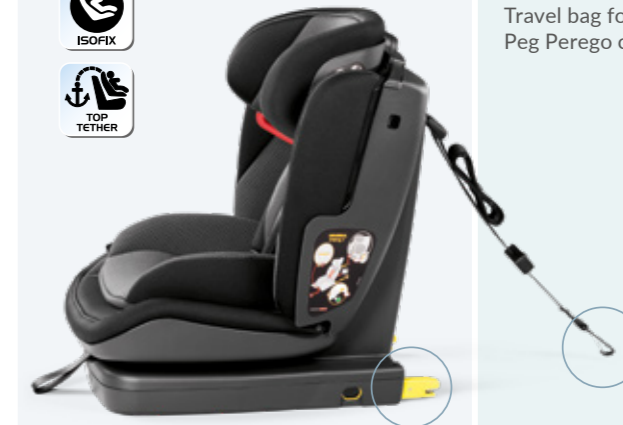

Gruppo 2-3 (15-36 kg), categoria SEMI UNIVERSALE, installato con Isofix (Top Tether opzionale) e utilizzato con le cinture di sicurezza a 3 punti dell'auto.

Group 2-3 (15-36 kg), SEMI UNIVERSAL category, installed with Isofix (Top Tether optional) and used with 3-point car safety belts.

The Original Accessory

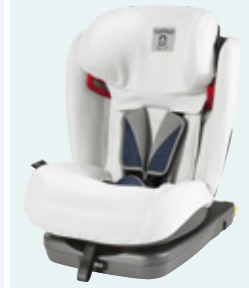

Clima Cover Viaggio 1-2-3 Via
Rivestimento sfoderabile in Tencel®
Removable cover in Tencel®



Travel Bag Car Seat
Borsa di trasporto per seggiolini auto Peg Perego.
Travel bag for Peg Perego car seats.

1 anno year	9 kg	75 cm
12 anni years	36 kg	150 cm

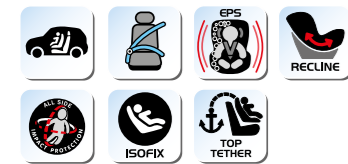



Bambini
Children



Viaggio 2-3 Surefix

Gruppo 2-3

(da 15 a 36 kg)
da 3 a 12 anni

IL SEGGIOLINO CHE SEGUE
LA CRESCITA DEL TUO BAMBINO.

Group 2-3

(from 15 to 36 kg)
from 3 to 12 years

THE CAR SEAT THAT ACCOMPANIES
YOUR CHILD'S GROWTH.

Pratici ganci SUREFIX che assicurano
stabilità al seggiolino anche in curva.

The practical SUREFIX connectors ensure that
the child seat is stable even when turning corners.

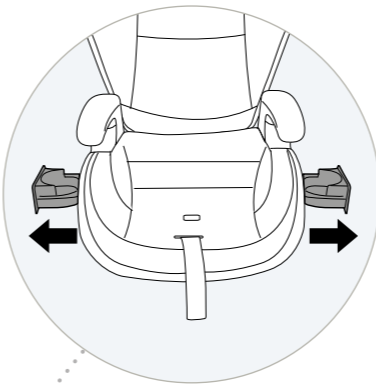

Seduta con due portabibite
laterali a scomparsa.

The seat has a pull-out drink
holder on each side.

ADJUSTABLE SIDE IMPACT PROTECTION
Sistema di protezione agli impatti laterali, regolabile
in 6 posizioni, per garantire la massima sicurezza
in ogni momento della crescita del bambino.

ADJUSTABLE SIDE IMPACT PROTECTION
6-position adjustable side impact system,
guaranteeing maximum safety as your child grows.

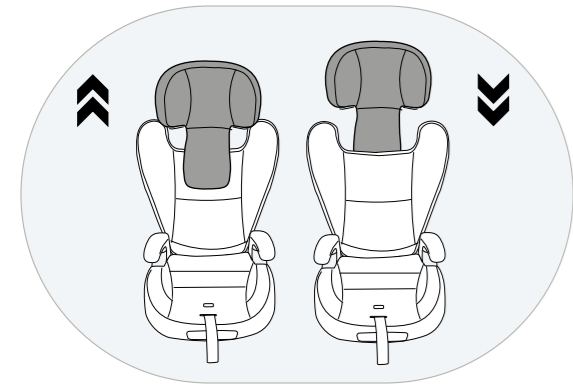

L'ampio schienale reclinabile,
con la seduta regolabile,
garantisce al bambino
lungi viaggi comodi in completo
relax anche quando dorme.

The broad backrest and
adjustable seat allow the child
to fully relax on long journeys,
even when sleeping.

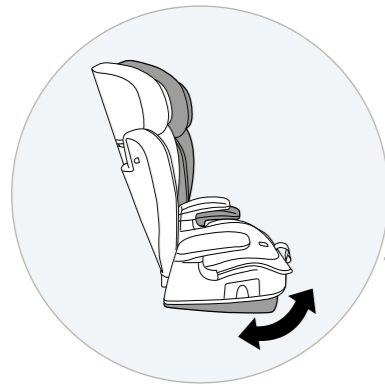

IN SENSO DI MARCIA.
DOPPIA OMOLOGAZIONE.
DUE MODI DI FISSARLO IN AUTO:
1: con le cinture di sicurezza
a 3 punti dell'auto;
2: con le cinture di sicurezza a 3
punti dell'auto e ganci Surefix.

FORWARD FACING.
DUAL TYPE-APPROVAL.
TWO WAYS TO FASTEN IT
TO THE CAR:
1: with 3-point safety belt;
2: with 3-point safety belt
and Surefix fasteners.



1

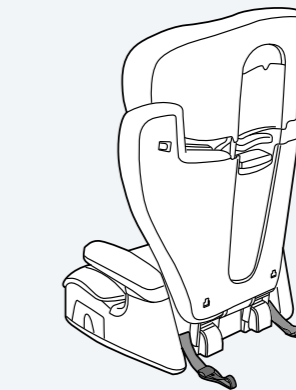

2

The Original Accessory



**Travel Bag
Car Seat**
Borsa di trasporto
per seggiolini auto
Peg Pérego.
Travel bag for
Peg Pérego car seats.



3
anni
years



15
kg



100
cm

12
anni
years

36
kg

150
cm

Viaggio 2-3 Flex

Gruppo 2-3

(da 15 a 36 kg)
da 3 a 12 anni

IL SEGGIOLINO AUTO PIEGHEVOLE
E PRATICO DA TRASPORTARE.

Group 2-3

(from 15 to 36 kg)
from 3 to 12 years

THE FOLDING CAR SEAT
THAT IS EASY TO TRANSPORT.

ALL SIDE IMPACT PROTECTION,
MASSIMA SICUREZZA
Offre sicurezza in tutti i punti sensibili del corpo.

ALL SIDE IMPACT PROTECTION,
MAXIMUM SAFETY
Guarantees safety for all the sensitive
points of the body.

3: Le protezioni laterali si aprono
permettendo di variare la
larghezza del seggiolino di ben
10 centimetri.

3: The side protections open out
so the width of the seat can be
extended by up to 10 centimetres.

BLIND LOCK SYSTEM

Evita che il seggiolino venga inavvertitamente
sganciato da un altro passeggero.

BLIND LOCK SYSTEM

Prevents the car seat from being accidentally
released by another passenger.



PRATICO, SI RICHIUDE SU SE STESSO

Lo schienale del seggiolino
auto Viaggio 2-3 Flex
si piega su se stesso
quando inutilizzato.

PRACTICAL, FOLDS ONTO ITSELF

The backrest on the
Viaggio 2-3 Flex folds onto
itself when not in use.



2 portabibite laterali
a scomparsa.

2 retractable side
cupholders.

4D TOTAL ADJUST

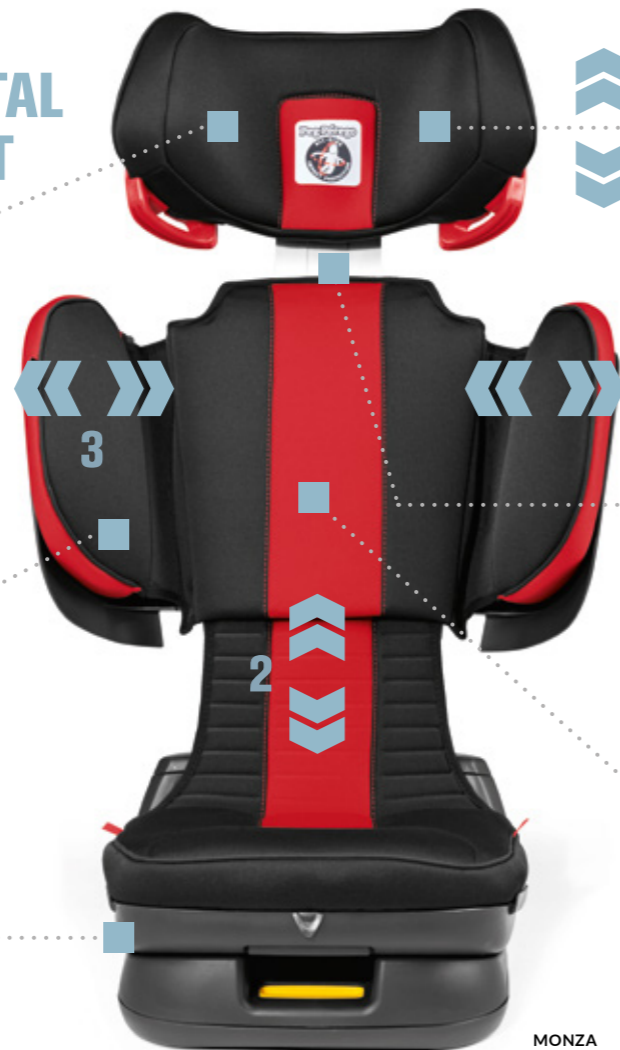

1: GUSCIO INTERNO IN EPS
per l'assorbimento dell'energia
d'impatto. Il poggiatesta si
regola in altezza in 5 posizioni
rispetto allo schienale.

1: EPS-LINED HEADREST
for best impact protection
and durability. The headrest
can be adjusted to 5 height
positions in relation to the
backrest.

Schienale rinforzato
in alluminio. Ulteriore
protezione da tamponamenti.

Aluminium-reinforced
backrest. Ensures extra safety
and protection in the case of
collisions.

2: La parte superiore (schienale
e poggiatesta) si regola in
altezza in 3 posizioni.

2: The upper part (backrest
and headrest) can be adjusted
to 3 positions.



CRYSTAL BLACK



LICORICE



4: La seduta anatomica,
regolabile con una sola mano,
si reclinata in 5 posizioni.

4: The ergonomic seat can
be adjusted with just one
hand and reclines in 5
positions.



IN SENSO DI MARCIA.
DOPPIA OMOLOGAZIONE.
DUE MODI DI FISSARLO IN AUTO:
1: con le cinture di sicurezza
a 3 punti dell'auto;
2: con le cinture di sicurezza
a 3 punti dell'auto e agganci
Isofix dell'auto.

FORWARD FACING.
DUAL TYPE-APPROVAL.
TWO WAYS TO FASTEN IT TO
THE CAR:
1: with the car's 3-point seat belt;
2: with the car's 3-point seat belt
and Isofix attachment points.



1



2



BASE SUREFIX INTEGRATA, MASSIMA
STABILITÀ ANCHE IN CURVA.
THE INTEGRATED SUREFIX BASE
ENSURES STABLE CORNERING.

The Original Accessory



Travel Bag Viaggio 2-3 Flex

Borsa di trasporto
con tracolla per
seggiolino auto
Viaggio 2-3 Flex.

Travel bag with
shoulder belt for
Peg Perego Viaggio
2-3 Flex car seat.



3
anni
years

15
kg

12
anni
years



15
kg

36
kg

100
cm

150
cm

Viaggio 2-3 Shuttle Plus

Gruppo 2-3

(da 15 a 36 kg)
da 3 a 12 anni

IL SEGGIOLINO AUTO 2 IN 1.
PROTEZIONE REGOLABILE
DAI 3 AI 12 ANNI.

Group 2-3

(from 15 to 36 kg)
from 3 to 12 years

THE 2 IN 1 CAR SEAT.
ADJUSTABLE PROTECTION
FOR CHILDREN
3 TO 12 YEARS OLD.



Schienale rinforzato in alluminio.
Ulteriore protezione da tamponamenti.

Aluminium-reinforced backrest.
Ensures extra safety and protection
in the case of collisions.

3: ALL SIDE IMPACT PROTECTION,
MASSIMA SICUREZZA
Offre sicurezza in tutti
i punti sensibili del corpo.

3: ALL SIDE IMPACT PROTECTION,
MAXIMUM SAFETY
Guarantees safety for all
the sensitive points of the body.

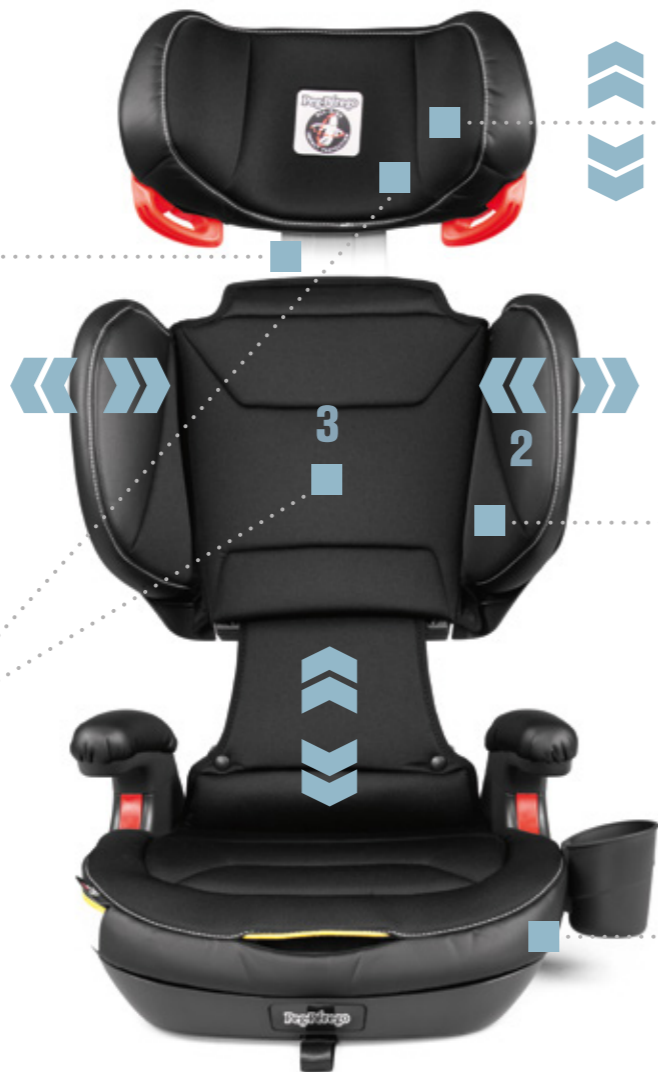

1: GUSCIO INTERNO IN EPS
per l'assorbimento dell'energia d'impatto.
Il poggiatesta si regola in altezza in
5 posizioni rispetto allo schienale.

1: EPS-LINED HEADREST
for best impact protection and durability.
The headrest can be adjusted to 5 height
positions in relation to the backrest.

2: La parte superiore (schienale
e poggiatesta) si regola in
altezza in 3 posizioni.

2: The upper part (backrest
and headrest) can be adjusted
to 3 positions.

BLIND LOCK SYSTEM

Evita che il seggiolino venga inavvertitamente
sganciato da un altro passeggero.

BLIND LOCK SYSTEM

Prevents the car seat from being accidentally
released by another passenger.



Schienale removibile.
Removable backrest.



Portabibite (incluso).
Cup holder (included).



SHOULDER CLIP
Garantisce la corretta posizione
della cintura sopra la spalla.
SHOULDER CLIP
Guarantees the correct position
of the belt above the shoulder.



IN SENSO DI MARCIA.
DUE MODI DI FISSARLO IN AUTO:
1: con le cinture di sicurezza
a 3 punti dell'auto;
2: con le cinture di sicurezza
a 3 punti dell'auto e agganci
Isofix dell'auto.

FORWARD FACING.
TWO WAYS TO FASTEN IT
TO THE CAR:
1: with the car's 3-point seat belt;
2: with the car's 3-point seat belt
and Isofix attachment points.

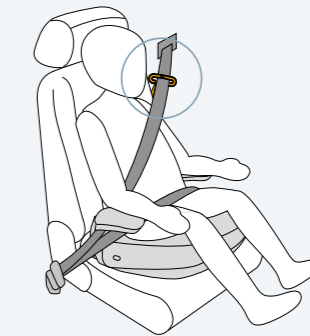
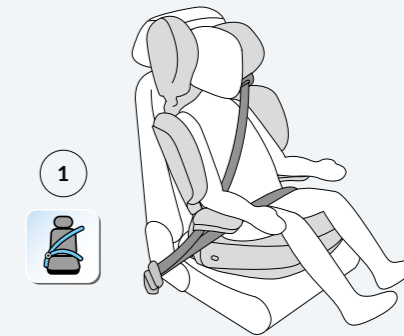

2

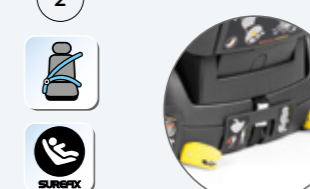

**BASE SUREFIX INTEGRATA, MASSIMA
STABILITÀ ANCHE IN CURVA.**
THE INTEGRATED SUREFIX BASE
ENSURES STABLE CORNERING.

The Original Accessory



**Travel Bag
Car Seat**
Borsa di trasporto
per seggiolini auto
Peg Perego.
Travel bag for
Peg Perego car seats.



3
anni
years

12
anni
years



15
kg

36
kg



100
cm

150
cm

Viaggio 2-3 Shuttle

Gruppo 2-3

(da 15 a 36 kg)
da 3 a 12 anni

IL SEGGIOLINO AUTO PER I PIÙ GRANDICELLI.

Group 2-3

(from 15 to 36 kg)
from 3 to 12 years

THE CAR SEAT FOR CHILDREN.

DUAL LAYER COMFORT

Offre massimo comfort grazie ai due strati di materiale espanso:

- il primo più rigido, in EPS (Expanded Poly Styrene), aiuta ad assorbire le decelerazioni in caso di incidente;
- il secondo più morbido, in poliuretano espanso, ha una struttura ergonomica per offrire il massimo comfort anche nei viaggi più lunghi.

DUAL LAYER COMFORT

Extremely comfortable thanks to its double layer of expanded material:

- the first layer is EPS (Expanded Polystyrene), which helps absorb deceleration in the event of a collision;
- the second layer is expanded polyurethane, which is softer and ergonomically shaped to offer maximum comfort even during very long journeys.

COMODO BRACCIOLO

Regala la piacevole sensazione di essere seduti su una poltroncina.

COMFORTABLE ARMREST

Gives the pleasant impression of being seated in a little armchair.

BLIND LOCK SYSTEM

Evita che il seggiolino venga inavvertitamente sganciato da un altro passeggero.

BLIND LOCK SYSTEM

Prevents the car seat from being accidentally released by another passenger.



Portabibite (incluso).

Cup holder (included).



Maniglia di trasporto.

Carrying handle.



MONZA



LICORICE



CRYSTAL BLACK

Comoda seduta realizzata in schiuma espansa come i veri sedili delle automobili.

Seat made of expanded foam, like real automobile seats.



IN SENSO DI MARCIA. DOPPIA OMOLOGAZIONE. DUE MODI DI FISSARLO IN AUTO:
1: con le cinture di sicurezza a 3 punti dell'auto;
2: con le cinture di sicurezza a 3 punti dell'auto e agganci Isofix dell'auto.

FORWARD FACING. DUAL TYPE-APPROVAL. TWO WAYS TO FASTEN IT TO THE CAR:
1: with the car's 3-point seat belt;
2: with the car's 3-point seat belt and Isofix attachment points.



SHOULDER CLIP

Garantisce la corretta posizione della cintura sopra la spalla.

SHOULDER CLIP

Guarantees the correct position of the belt above the shoulder.



BASE SUREFIX INTEGRATA, MASSIMA STABILITÀ ANCHE IN CURVA.

THE INTEGRATED SUREFIX BASE ENSURES STABLE CORNERING.

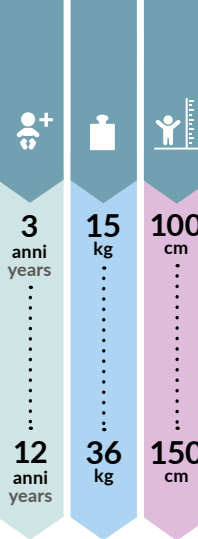

Legenda Legend

	Posizione trasversale al senso di marcia.	Transverse facing.
	In senso opposto al senso di marcia.	Rearward facing.
	In senso di marcia.	Forward facing.
	Non utilizzare con airbag inserito.	Do not use on seats fitted with an airbag.
	Sistema Viaggio Isofix.	Isofix Travel System.
	Viaggio Sistem i-Size.	Travel System i-Size.
	Aggancio con cinture di sicurezza in auto.	Use of safety belts in the car.
	Kit auto per navicella.	Car Kit for bassinet.
	Sistema Isofix.	Isofix System.
	Sistema Surefix.	Surefix System.
	Sistema i-Size.	i-Size System.
	Gancio Top Tether (TT).	Top Tether (TT) fastening.

	All Side Impact Protection.	All Side Impact Protection.
	ASIP: Adjustable Side Impact Protection.	ASIP: Adjustable Side Impact Protection.
	TRI-STAGE CUSHION.	TRI-STAGE CUSHION.
	EPS-EXPANDED POLYSTYRENE: Per l'assorbimento dell'energia d'impatto.	EPS-EXPANDED POLYSTYRENE: Absorbs impact energy.
	Sistema di aggancio automatico per il seggiolino auto.	Automatic car seat attachment system.
	Seggiolino reclinabile.	Multi-position recline.
	Base Isofix.	Isofix Base.
	Base i-Size.	i-Size Base.
	Belted Base.	Belted Base.
	Asola per appendere il suo gioco preferito.	Loop to dangle baby's favorite light toy.
	UPF50+	UPF50+

Pesi e misure Weights and measures

Primo Viaggio SL		3,8 kg
	43 x 65 x 60 cm	L-W H-H P-D
Primo Viaggio i-Size		4,5 kg
	44 x 66 x 67 cm	L-W H-H P-D
Viaggio FF105		7,7 kg
	44 x 55 x 53 cm	L-W H-H P-D
Viaggio1 Duo-Fix K		10 kg
	45 x 65,5 x 55 cm	L-W H-H P-D
Viaggio 1-2-3 Via		11,8 kg
	44 x 59,5 x 54,5 cm	L-W H-H P-D
	50 x 85 x 54,5 cm	L-W H-H P-D
Viaggio 2-3 Surefix		5,3 kg
	41,5 x 68,5 x 45,5 cm	L-W H-H P-D
Viaggio 2-3 Flex		6,7 kg
	44 x 66 x 56 cm	L-W H-H P-D
	44 x 25 x 60 cm	L-W H-H P-D
Viaggio 2-3 Shuttle Plus		6,8 kg
	44 x 68 x 45 cm	L-W H-H P-D
	44 x 24 x 40,5 cm	L-W H-H P-D
Viaggio 2-3 Shuttle		3 kg
	44 x 24 x 40,5 cm	L-W H-H P-D
Isofix Base		5 kg
	35 x 14 x 58 cm	L-W H-H P-D
Base i-Size		5,2 kg
	35 x 18,5 x 58 cm	L-W H-H P-D
Belted Base		1,9 kg
	41,5 x 40 x 54 cm	L-W H-H P-D



Certificazioni e ratings: sinonimi di qualità e sicurezza. Certifications and ratings: synonyms of quality and safety.

Peg Perego è un'azienda certificata ISO 9001 dal 2002. La certificazione, fortemente voluta da Peg Perego offre a chi ci sceglie il massimo della trasparenza sul nostro modo di operare. Al primo posto viene naturalmente l'affidabilità dei prodotti, che superano i più severi test di sicurezza. I seggiolini auto prodotti da Peg Perego vengono distribuiti in Europa, Nordamerica, America Latina e Australia, Paesi nei quali sono certificati secondo normative differenti tra loro ma tutte molto severe. Per questo i nostri prodotti sono conformi alle Normative Europee ECE R44 e ECE R129, ma eccedono questi standard per performance e sicurezza. Non solo certificazioni obbligatorie, però: i nostri prodotti vengono selezionati ed esaminati dalle maggiori agenzie di rating in Europa: tra queste le più importanti sono lo Stiftungwarentest in Germania, lo ÖAMTC in Austria, il TCS in Svizzera, il RACC in Spagna, l'ACI in Italia.

Queste agenzie testano i nostri prodotti secondo il protocollo Euro NCAP presso il famoso Crash Test Center ADAC di Monaco di Baviera dove i prodotti sono collaudati in urto laterale e in urto frontale a una velocità superiore del 40% alla velocità richiesta dalla norma europea. Anche l'ergonomia, la facilità d'uso e la qualità dei materiali vengono inclusi nei test al fine di dare una valutazione globale ai nostri prodotti.

Peg Perego: qualità e sicurezza certificate.

- 1) Omologazioni obbligatorie europee per prodotti in auto R44 e R129.
- 2) Certificazioni europee di prodotto: Navicelle EN 1466, Passeggini EN 1888.

Peg Perego has been an ISO 9001 certified company since 2002. Peg Perego was extremely keen to obtain this certification, which guarantees maximum transparency about our working methods for our customers. Of course the top priority is the reliability of the products, which are put through the strictest safety tests. Car seats manufactured by Peg Perego are distributed in Europe, North America, Latin America and Australia, where they are certified according to different standards, all of which are very strict. Because of this, our products comply with European Standards ECE R44 and ECE R129, but they exceed the requirements of this standard in terms of performance and safety. They do not only comply with mandatory certifications: our products are selected and examined by the leading European rating agencies, most importantly by Stiftungwarentest in Germany, ÖAMTC in Austria, TCS in Switzerland, RACC in Spain and ACI in Italy.

Our car seats are also tested in keeping with the Euro NCAP protocol at the famous ADAC: Crash Test Centre in Munich, where the products are subjected to a side impact test and a frontal impact test at a speed 40% higher than the speed required by European standards. The tests include parameters such as ergonomics, ease of use and quality of materials, so as to give our products a fully comprehensive rating.

Peg Perego: certified quality and safety.

- 1) R44 and R129 obligatory European type-approvals for products in cars.
- 2) European product certifications: Bassinet EN 1466, Strollers EN1888.



1



2



Le performance dei nostri seggiolini - Our car seats' performance.

ETA' AGE	Nascita Birth	8 mesi months	9 mesi months	12 mesi months	15 mesi months	24 mesi months	30 mesi months	36 mesi months	4 anni years	6 anni years	12 anni years
PESO WEIGHT		9 kg	10 kg		13 kg		15 kg		18 kg	20 kg	36 kg
ALTEZZA HEIGHT	40 cm	71 cm	75 cm	80 cm	83 cm		100 cm		105 cm	125 cm	150 cm
Kit Auto Culla Elite Kit Auto Culla Primonido	[Blue hatched]		[Blue hatched]								
Primo Viaggio SL	[Blue hatched]		[Blue hatched]								
Primo Viaggio i-Size	[Blue hatched]		[Blue hatched]								
Viaggio FF105 (+ Base i-Size)		[Blue hatched]		[Blue hatched]		[Blue hatched]		[Blue hatched]			
Viaggio 1 Duo - Fix K			[Blue hatched]		[Blue hatched]		[Blue hatched]				
Viaggio 1-2-3 Via			[Blue hatched]		[Blue hatched]		[Blue hatched]		[Blue hatched]		
Viaggio 2-3 Surefix				[Blue hatched]		[Blue hatched]		[Blue hatched]		[Blue hatched]	
Viaggio 2-3 Flex				[Blue hatched]		[Blue hatched]		[Blue hatched]		[Blue hatched]	
Viaggio 2-3 Shuttle Plus				[Blue hatched]		[Blue hatched]		[Blue hatched]		[Blue hatched]	
Viaggio 2-3 Shuttle				[Blue hatched]		[Blue hatched]		[Blue hatched]		[Blue hatched]	

